

TD SILENT SERIES

B



DESCRIPTION

The TD Silent Series of low-profile mixed-flow in-line fans incorporates a break-through in noise reduction resulting in units that operate very quietly. The low noise levels are achieved through the technically advanced design of the internal construction, which does not impede on the air flow performance of the fan.

There are 6 models in the series, ranging from 100 to 315mm diameter spigot sizes.

Typical Applications

Suited to environments that are noise sensitive such as conference/seminar rooms as well as homes, hotels, offices and libraries. Can be used for both supply and exhaust air applications as well as hot and cold air transfer.

Features

- High performance mixed-flow impeller.
- Low noise operation.
- Vibration absorbing elements are integrated into the advanced body design.
- 360° rotating junction box makes connection of power cable easier (applicable for 100, 125, 150 and 200mm sizes only).
- Integral mounting foot makes installation more simple.
- 1 to 30 minute run-on timer available on 100 to 200mm models.
- Includes plug and lead for easy installation.
- Convenient 2-speed motor, factory set to high speed (single speed on models with run-on timer).
- Fan body can be easily removed without disturbing connected ductwork.

Construction

Models 250/100 to 800/200 - casings manufactured from reinforced, injection moulded, polypropylene plastic. Impellers are made of injection moulded plastic and are a mixed-flow design.

Models 1300/250 and 2000/315 - casings manufactured from epoxy coated steel. Impellers are made of aluminium and of mixed-flow design.

Motors

Type: Standard models - 2-speed, squirrel cage induction motor.
Models with run-on timer - Single-speed, squirrel cage induction motor.

Electricity supply - 230V, single-phase, 50Hz.

Bearings - sealed for life, ball.

Speed-controllable using VA type speed controllers in high speed only. Not applicable to models with run-on timer.

Class B Insulation, IP44.

See pages O-3/4 for details of these motors.

Internal Thermal Protection

Manual-reset thermal overload protection device in accordance with mandatory requirements for in-line fans, AS/NZS60335-2-80:2016

Testing

Air flow tests to ISO5801: Part1, 1997 and AMCA 210-99

Noise to ISO 13347-3 2004

SUGGESTED SPECIFICATION

The In-line fans shall be of the TD Silent Series as supplied by Fantech Pty. Ltd.

Impellers shall be of mixed-flow design and driven by single-phase motors with thermal overload protection.

Fans shall include vibration absorbing elements and sound absorbing material.

They shall also include an integral mounting foot and a power lead with plug.

The fan body can be removed without disturbing connecting ductwork.

All fans shall be fully tested to ISO5801: Part 1, 1997 or AMCA 210-99 for air flow and ISO13347-3, 2004 for noise.

HOW TO ORDER

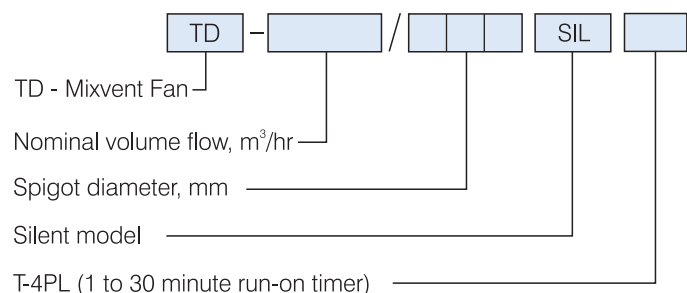

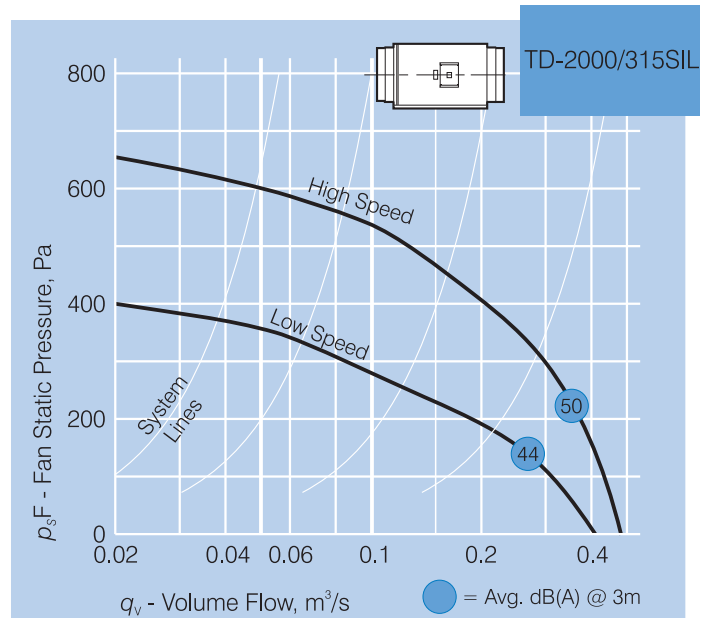
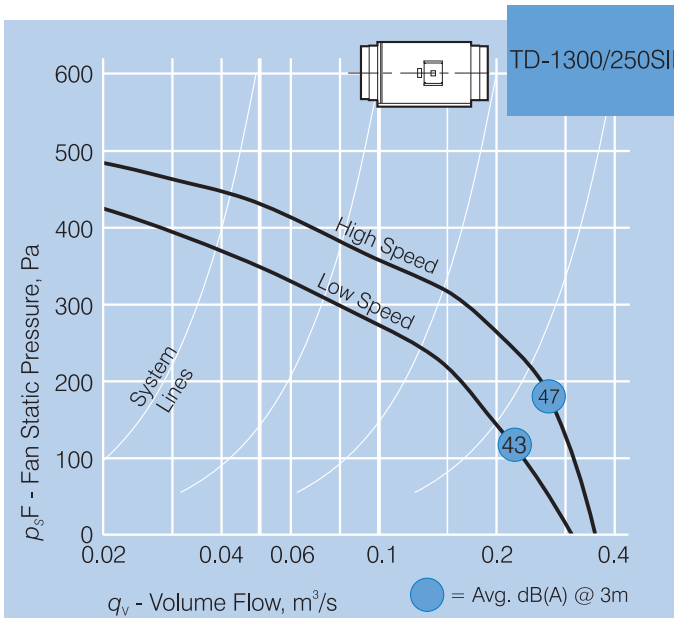
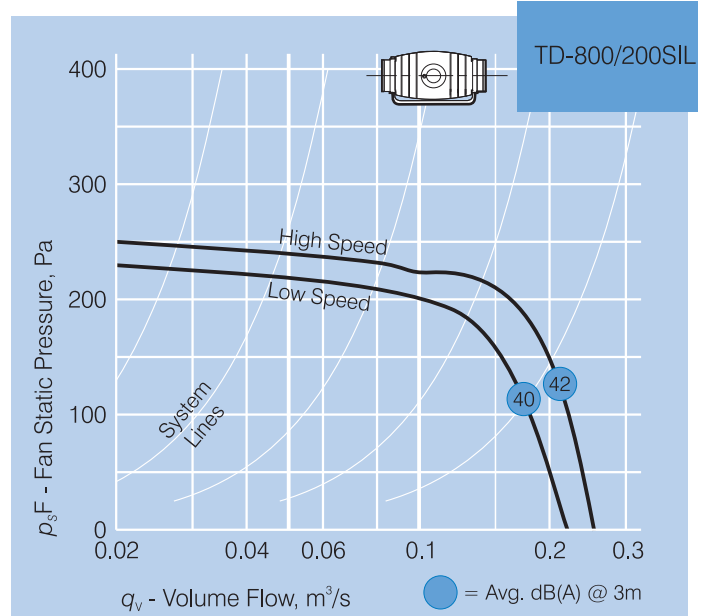
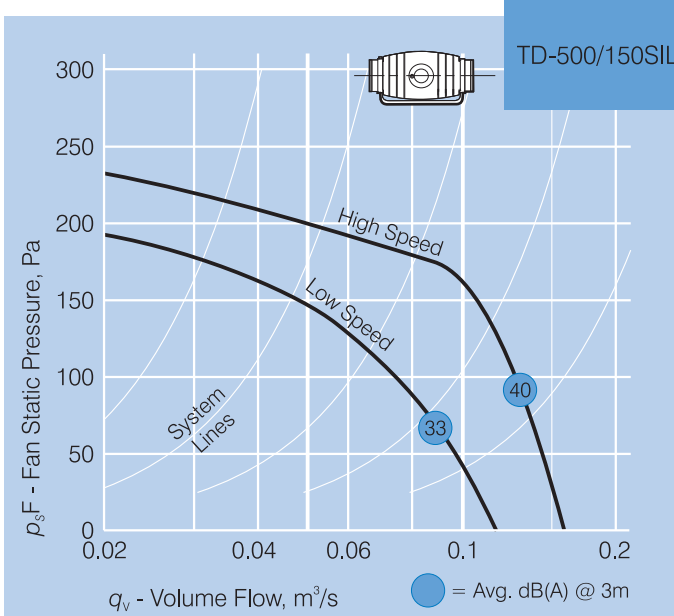
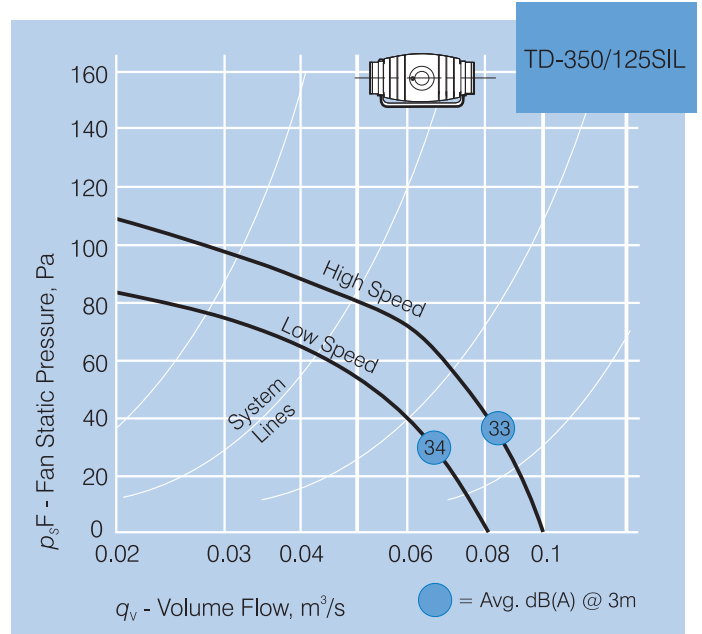
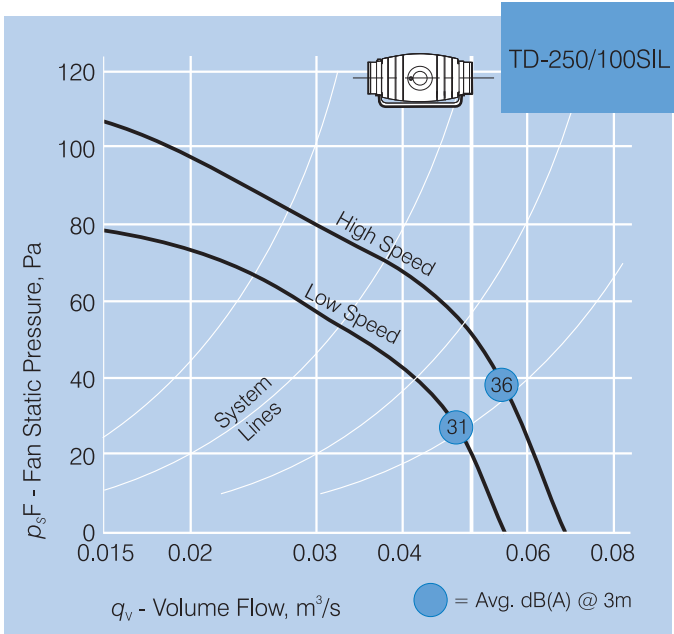





TD SILENT SERIES

NOISE DATA

Model Number	Speed	Type	dB(A) @ 3m	In-duct Sound Power Levels							
				L _w dB re 1pW							
TD-...				63	125	250	500	1k	2k	4k	8k
250/100SIL	High	Inlet	36	50	52	55	56	52	43	37	31
250/100SIL	High	Outlet	33	52	51	52	55	45	39	35	29
250/100SIL	High	Breakout	24	50	48	49	43	35	30	24	19
250/100SIL	Low	Inlet	31	49	50	52	49	48	38	31	28
250/100SIL	Low	Outlet	28	51	50	50	49	42	34	30	26
250/100SIL	Low	Breakout	19	49	45	45	36	28	24	18	19
350/125SIL	High	Inlet	33	48	43	48	54	49	41	36	31
350/125SIL	High	Outlet	32	51	43	49	53	47	39	35	30
350/125SIL	High	Breakout	20	48	38	39	40	36	22	17	15
350/125SIL	Low	Inlet	34	48	45	49	49	53	38	33	27
350/125SIL	Low	Outlet	29	49	45	49	48	47	34	31	27
350/125SIL	Low	Breakout	19	45	40	41	36	36	20	15	15
500/150SIL	High	Inlet	40	51	49	57	59	55	53	45	43
500/150SIL	High	Outlet	41	61	51	62	61	57	49	43	39
500/150SIL	High	Breakout	22	39	35	48	40	35	32	17	14
500/150SIL	Low	Inlet	33	51	47	50	53	48	43	36	31
500/150SIL	Low	Outlet	33	51	47	53	53	48	40	32	28
500/150SIL	Low	Breakout	17	46	39	38	36	33	27	17	16
800/200SIL	High	Inlet	42	51	54	55	58	58	57	53	47
800/200SIL	High	Outlet	44	68	61	58	61	59	57	54	48
800/200SIL	High	Breakout	19	36	45	36	36	34	32	20	15
800/200SIL	Low	Inlet	40	50	51	57	55	58	53	48	43
800/200SIL	Low	Outlet	40	63	61	63	56	55	53	49	43
800/200SIL	Low	Breakout	18	37	40	29	34	35	29	16	12
1300/250SIL	High	Inlet	47	58	59	71	63	61	59	55	52
1300/250SIL	High	Outlet	54	56	62	70	72	71	62	51	48
1300/250SIL	High	Breakout	36	54	48	57	46	54	46	36	38
1300/250SIL	Low	Inlet	43	61	56	66	59	56	54	50	47
1300/250SIL	Low	Outlet	49	55	60	66	68	66	56	46	42
1300/250SIL	Low	Breakout	32	55	48	51	43	50	41	31	33
2000/315SIL	High	Inlet	50	60	65	72	65	65	63	59	56
2000/315SIL	High	Outlet	55	64	71	75	70	73	64	50	50
2000/315SIL	High	Breakout	40	49	53	56	52	56	53	49	44
2000/315SIL	Low	Inlet	44	60	63	68	59	58	55	52	48
2000/315SIL	Low	Outlet	49	60	69	69	65	66	57	43	42
2000/315SIL	Low	Breakout	34	50	56	52	47	50	46	43	37

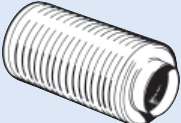
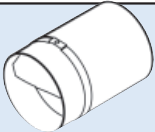
Sound Levels are taken at medium-level pressure.

ANCILLARY EQUIPMENT

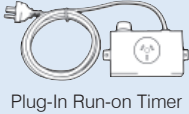
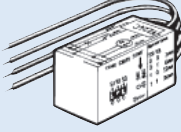
 TSS1 - 2-Speed switch [†] Ref. Section B	 CC - Attenuators Ref. Section H	 SJK - Backdraft Damper Ref. Section J (sizes 150 to 200 only)
 RSK - Backdraft Dampers Ref. Section J	 FC - Fast clamp Ref. Section J	 FGR - Filter Unit Ref. Section J
 VA - Speed controller [†] Ref. Section M	 Plug-In Run-on Timer and Speed Controller [†] Ref. Section M	 VZ - Run-on timer [†] Ref. Section M

[†] Not suitable for models with run-on timer

DIMENSIONS

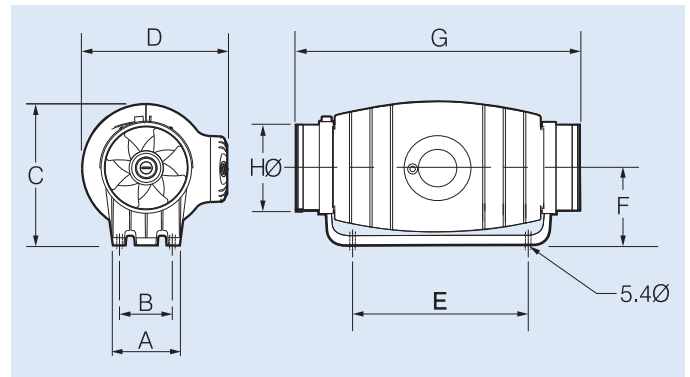

Model Number	Dimensions, mm							
	A	B	C	D	E	F	G	HØ
TD-..								
250/100SIL	100	83	223	233	250	121	575	97
350/125SIL	100	83	223	233	250	121	462	123
500/150SIL	116	96	245	251	250	134	484	147
800/200SIL	145	129	296	296	340	164	568	198

TECHNICAL DATA

Model Number	Fan Speed rev/sec	Avg. dB(A) @ 3m	TD.. 1 ph. Watts	TD.. 1 ph. Amps	Max. amb °C	App. wt. kg
TD-..						
250/100SIL	37 / 31	36 / 31	24 / 18	0.11 / 0.10	40	5.4
250/100SILT-4PL	37	36	24	0.11	40	5.4
350/125SIL	38 / 32	33 / 34	30 / 22	0.13 / 0.10	40	4.9
350/125SILT-4PL	38	33	30	0.13	40	4.9
500/150SIL	42 / 33	40 / 33	50 / 44	0.22 / 0.19	60	6.0
500/150SILT-4PL	42	40	50	0.22	60	6.0
800/200SIL	46 / 41	42 / 40	95 / 90	0.45 / 0.43	60	8.7
800/200SILT-4PL	46	42	95	0.45	60	8.7
1300/250SIL	42 / 36	47 / 43	197 / 145	0.83 / 0.61	60	20
2000/315SIL	44 / 38	50 / 44	297 / 191	1.28 / 0.79	60	25

Values shown are High Speed / Low Speed

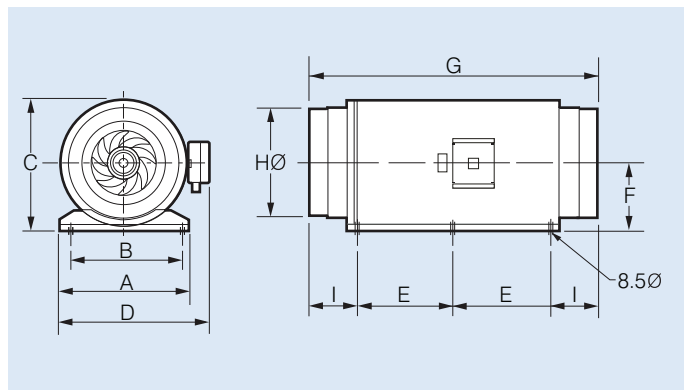

Model Number	Dimensions, mm								
	A	B	C	D	E	F	G	HØ	I
TD-..									
1300/250SIL	300	280	331	387	200	171	680	248	140
2000/315SIL	370	335	373	432	260	192	825	312	152



Scan the QR Code to view more information online.

